

BU-22K+

- / Easy installation without markings or installation aids
- / Adjustable 2D fixing element
- / Invisible screws
- / For timber and metal frames

TECHNICAL DATA

Application areas	secondary closing edge hinge side
Doorleaf material	timber
Frame material	timber, alu, steel
Doortype	rebated door
Fire protection	yes
Min. delivery length	90 mm
Max. delivery length	3000 mm
Banddurchmesser	21 - 22 mm
Continuous function cycles	free of wear

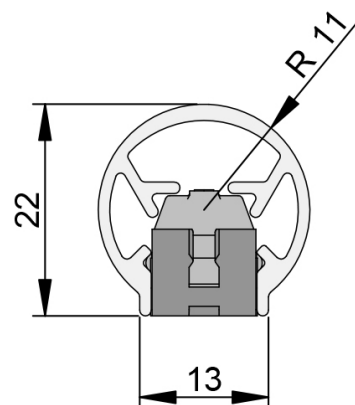

BU-22K+

