

# Montage / Installation

## Unidicht WS / ES / S12

### beidseitig / double actuation



Lässt niX durch.  
DICHTUNGSSYSTEME FÜR  
TÜREN UND TORE

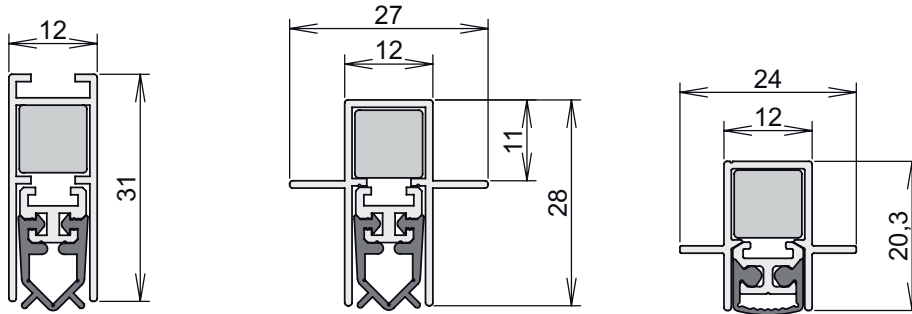

[www.athmer.de](http://www.athmer.de)

[www.athmer.de](http://www.athmer.de)

[www.athmer.de](http://www.athmer.de)

#### Athmer

Sophienhammer  
59757 Arnsberg-Müschede

Tel. +49 2932 477-500  
Fax +49 2932 477-100

info@athmer.de  
www.athmer.de

# Kürzen / cutting to size



Lässt niX durch.  
DICHTUNGSSYSTEME FÜR  
TÜREN UND TORE

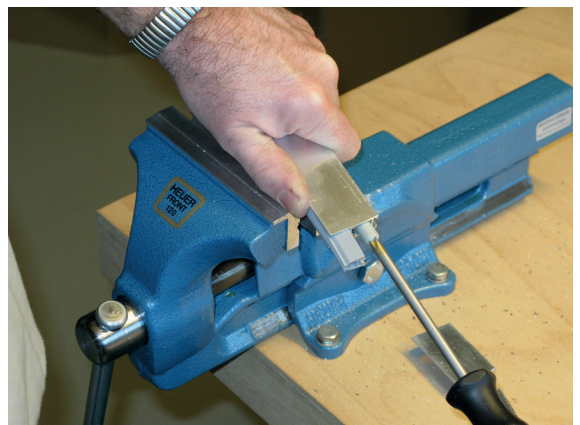
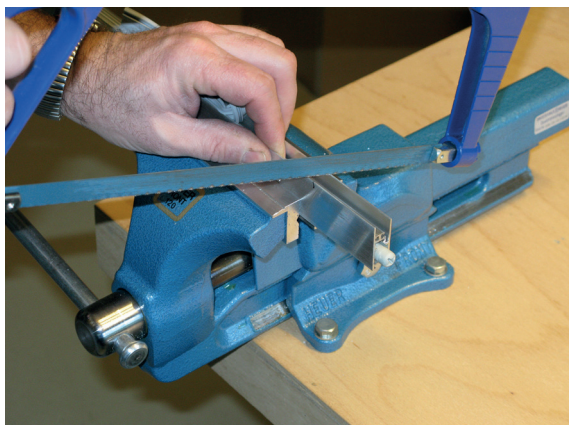
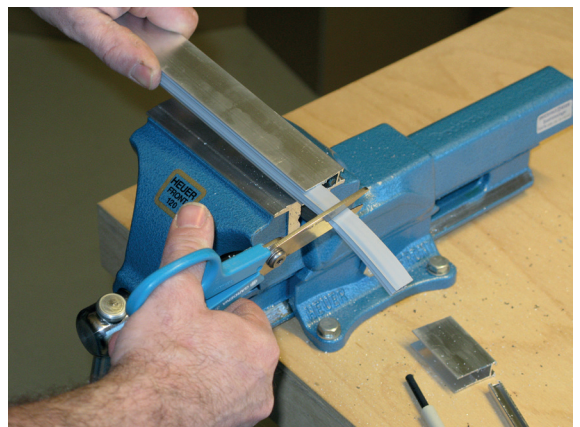
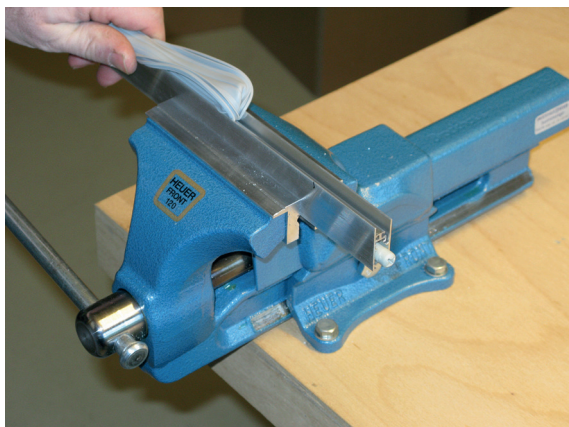
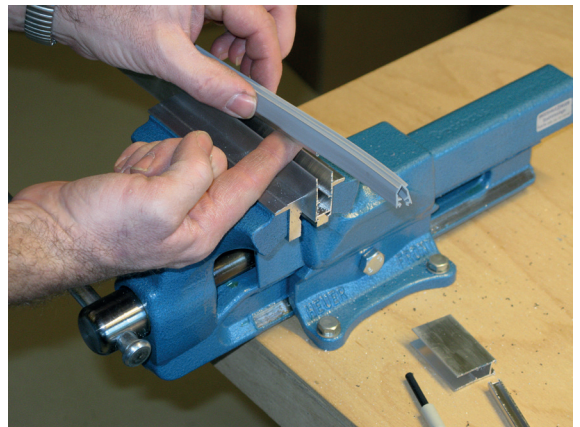
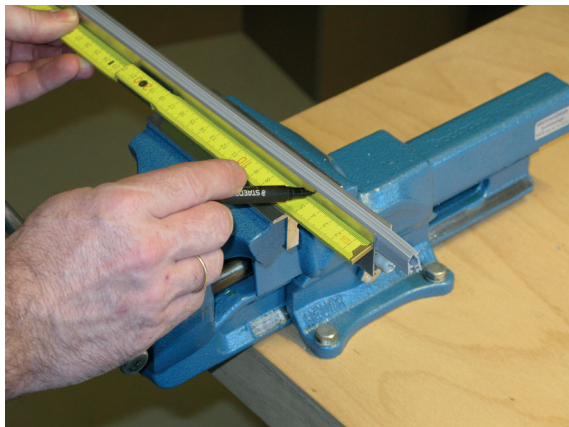
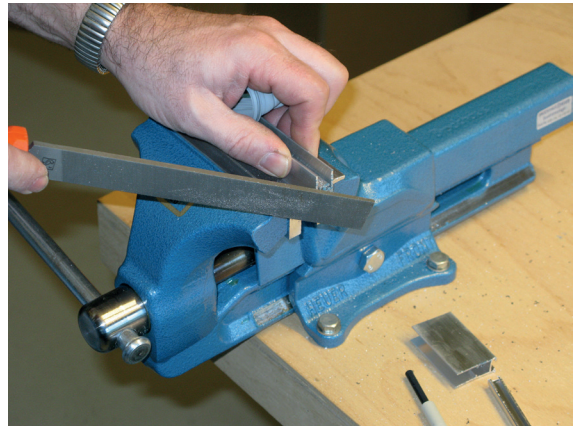

**Athmer** Sophienhammer  
59757 Arnsberg-Müschede

Tel. +49 2932 477-500  
Fax +49 2932 477-100

info@athmer.de  
www.athmer.de

# Anschlag / fixing



Lässt niX durch.  
DICHTUNGSSYSTEME FÜR  
TÜREN UND TORE

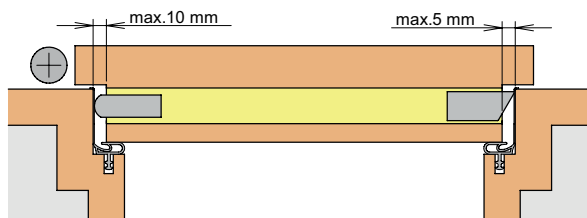
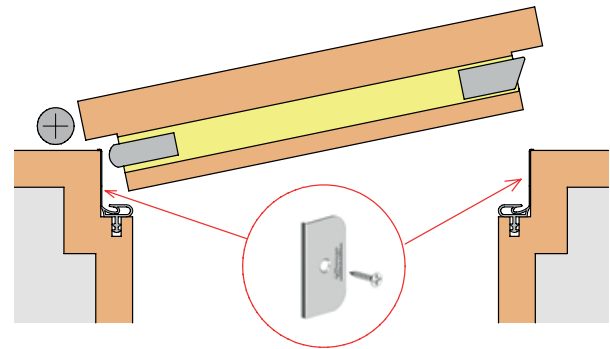
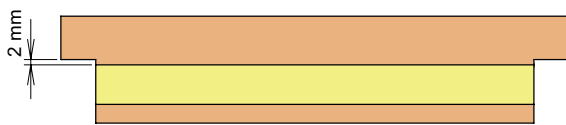

# Einstellen / adjustment



Lässt niX durch.  
DICHTUNGSSYSTEME FÜR  
TÜREN UND TORE

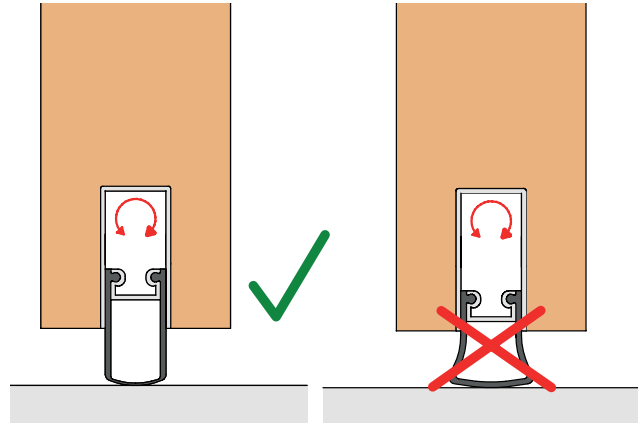
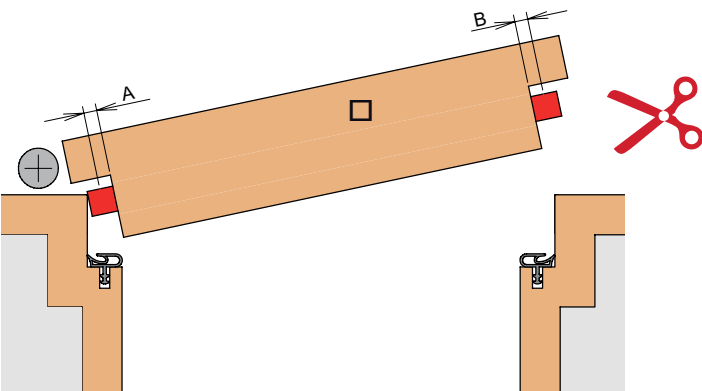
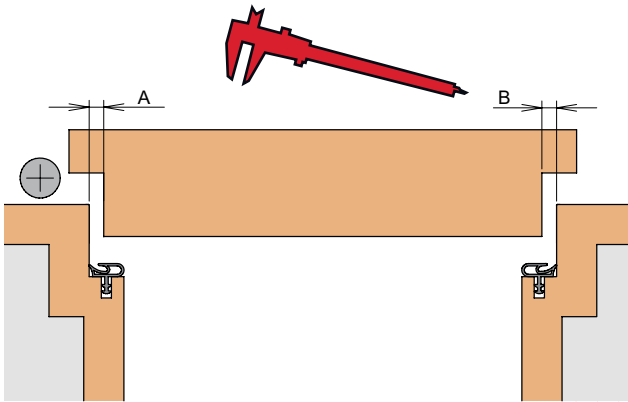

①

②

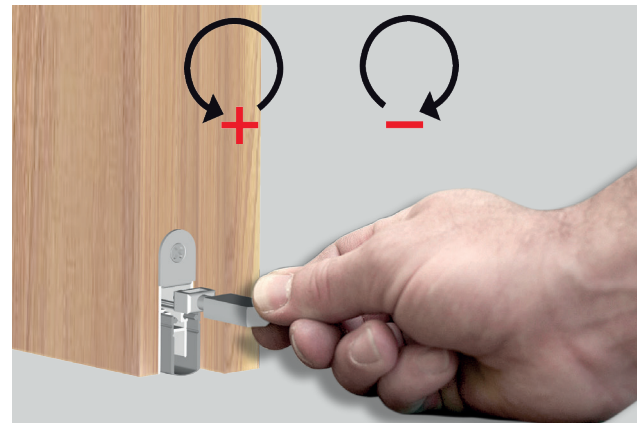
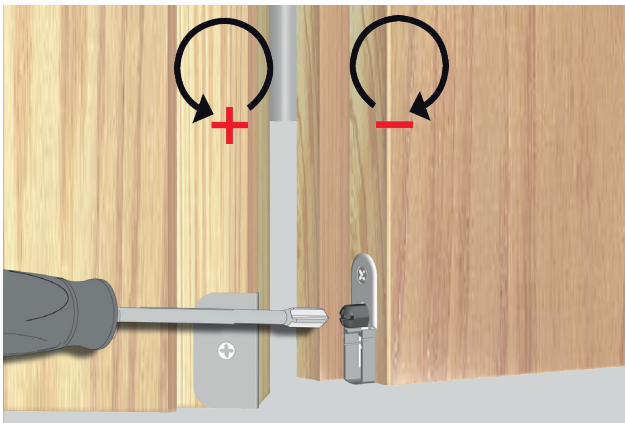

**Athmer**

Sophienhammer  
59757 Arnsberg-Müschede

Tel. +49 2932 477-500  
Fax +49 2932 477-100

info@athmer.de  
www.athmer.de